

HIGH END COMPONENTS

MKPg™ THREE-PHASE POWER CAPACITORS:

High End For The Heart Of Your PFC Installation

ECO FRIENDLY

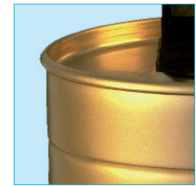

The construction of reliable equipment for power factor correction requires not only your excellent experience, but also top-class components. No compromise in quality and safety should be permitted when it comes to the key part of your PFC equipment. Being Germany's largest manufacturer of power capacitors, **ELECTRONICON** manufactures all components with highest care and expertise and is your best choice for capacitors and detuning reactors.

The dry-type phase shifters of our renowned MKPg™-series are environmentally friendly, compact, and very convenient to handle. They contain no liquids and are filled with a neutral, inert gas entirely harmless to environment. When disposing of the capacitors, no liquids or toxic gasses need to be considered.

By using the best low-loss, self-healing polypropylene films and sophisticated manufacturing techniques such as high-vacuum drying and special coating patterns, MKPg™ provide long service life with constant capacitance and high switching stability. As a matter of course, all our power capacitors are provided with BAM™ (overpressure break-action mechanism) as standard, for safe mode of failure.

Three-phase MKPg™ capacitors contain three delta-switched capacitor elements of short height and large diameter. This design substantially reduces inherent power losses and improves their current strength as compared with the slim, tall capacitors of many competitors.

Our capacitors may be mounted in any desired position. Should leakage occur, the leaking gas would escape into the atmosphere causing no undesirable effects to the adjacent equipment, e.g. damage, pollution, or staining.

Our original **CAPAGRIP™** terminals with their options K, L, and M guarantee optimum sealing of the capacitors, and offer convenient connection of cables up to 50mm². A special spring system guarantees reliable and durable operation of the clamp. They are rated IP20, i. e. protected against accidental finger contact with live parts. Designs L and M also permit the direct connection of discharge reactors and discharge resistor modules, as well as easy parallel connection of additional capacitors.

GENERAL TECHNICAL DATA

design	extruded aluminium can with stud M12 × 16, aluminium lid		
internal connection	delta		
tolerance of capacitance	- 5 ... + 10%		
terminals	CAPAGRIP™ three phase screw terminal, IP20		
safety device	BAM™ (overpressure break action mechanism)		
dielectric material	low-loss polypropylene, dry		
impregnant (filling material)	N ₂		
mounting position	any position		
permitted overvoltages	U _N +10%	8hrs/d	U _N +15% 30min/d
	U _N +20%	5min/d	U _N +30% 1min/d
	U _N × 3.05 max. peak rating		
test voltage btw. terminals	2.15 × U _N AC/2s		
test voltage terminals to case	> 2 × U _N +1000V AC/2s, typically 3600 or 4500V		
maximum permissible current	1.5...1.9 I _N details see data charts, higher values on request		
max. inrush current	300 × I _N		
dissipation losses	approx. 0.25W/kvar		
max. relative humidity	95%		
ambient temperature class	≤ 20kvar	- 40°/60 (max. 60°C, average 24h: 50°C)	
	> 20kvar	- 40°/D (max. 55°C, average 24h: 45°C)	
statistical life expectancy	> 150,000h		
standards	IEC 60831 (2003), VDE 0560-46/47 CSA C22.2 No. 190-M1985, UL Standard No. 810 GOST 1282-88, IS 13340, IS 13341		
approval marks			

NO LIQUIDS - NO LEAKAGE

MKPg™ GAS-FILLED POWER CAPACITORS: Best for Mains and Nature



Q _c (kvar@U _N , 50Hz)		C _N (μF)	I _N U _{N1} (A)	I _{max} (A)	D ₁ x L ₁ (mm)	m (kg)	CAPA GRIP™	order no. pcs./	resistor	module
U _{N1} 440V	U _{N2} 400V							box		(<50V in **s from 440V)
5	4.2	3 × 28	3 × 6.6	3 × 12	60 × 230	0.5	K	275.526-502800	10	inclusive (42)
6.25	5	3 × 33	3 × 8	3 × 17	75 × 164	0.7	K	275.545-503300	5	inclusive (50)
10	8.3	3 × 57	3 × 14	3 × 25	75 × 230	1.3	K	275.546-505700	5	inclusive (43)
12.5	10	3 × 68	3 × 16	3 × 30	75 × 230	1.0	K	275.546-506800	5	inclusive (53)
14.1	11.6	3 × 77	3 × 19	3 × 33	85 × 230	1.3	K	275.556-507700	5	inclusive (49)
15	12.5	3 × 82	3 × 20	3 × 30	85 × 230	1.3	K	275.556-508200	5	inclusive (52)
20	16.6	3 × 111	3 × 27	3 × 49	95 × 230	1.5	L	275.166-511100	3	275.100-10180 (50)
25	20	3 × 137	3 × 33	3 × 56	100 × 230	1.7	L	275.176-513700	3	275.100-10120 (41)
25	20	3 × 137	3 × 33	3 × 53	95 × 245	1.6	L	275.168-513700	3	275.100-10120 (41)
28.2	23.2	3 × 154	3 × 37	3 × 56	116 × 230	2.3	L	275.186-515400	3	275.100-10120 (47)
30	25	3 × 166	3 × 40	3 × 56	116 × 230	2.3	L	275.186-516600	3	275.100-10120 (50)
30	25	3 × 166	3 × 40	3 × 56	95 × 280	2.0	L	275.169-516600	3	275.100-10120 (50)
40	33.3	3 × 221	3 × 53	3 × 75	116 × 280	2.6	M	275.389-522100	3	275.105-10100 (55)
-	40	3 × 265	3 × 58	3 × 75	136 × 280	3.7	M	275.399-526500	2	275.100-10082 (53)
U _{N1} 525V										
5		3 × 19	3 × 5.5	3 × 9	60 × 230	0.7	K	275.526-801900	10	inclusive (47)
10		3 × 38	3 × 11	3 × 20	75 × 230	1.0	K	275.546-703803	5	inclusive (32)
12.5		3 × 48	3 × 14	3 × 25	85 × 230	1.3	K	275.556-704803	5	inclusive (40)
20		3 × 77	3 × 22	3 × 40	100 × 230	1.7	L	275.176-707700	3	275.100-10180 (37)
25		3 × 96	3 × 28	3 × 50	116 × 230	2.3	L	275.186-809601	3	275.100-10180 (47)
30		3 × 115	3 × 33	3 × 56	116 × 280	2.6	L	275.189-811503	3	275.100-10180 (56)
40		3 × 154	3 × 44	3 × 72	136 × 245	3.7	M	275.398-715401	2	275.105-10120 (50)

Rated Voltage U_N

Root mean square of the max. permissible value of sinusoidal AC voltage in continuous operation.

The rated voltage must not be exceeded even in cases of malfunction. Bear in mind that capacitors in detuned equipment are exposed to a higher voltage than that of the rated mains voltage; this is caused by the connection of detuning reactor and capacitor in series. Consequently, capacitors used with reactors must have a voltage rating higher than that of the regular mains voltage.

Rated Power Q_c

Reactive power resulting from the ratings of capacitance, frequency, and voltage.

Current Rating I_N

RMS value of the current at rated voltage and frequency, excluding harmonic distortion, switching transients, and capacitance tolerance.

Maximum RMS

Current Rating I_{max}

Maximum rms value of permissible current in continuous operation. In accordance with EN 60831 all ELECTRONICON capacitors are rated at least 1.3I_N, allowing for the current rise from permissible voltage and capacitance tolerances as well as harmonic distortion. Continuous currents that exceed these values will lead to a build-up of heat in the capacitor and - as a result - reduced lifetime or premature failure. Permanent excess current may even result in failure of the capacitor's safety mechanisms, i. e. bursting or fire.

EASE OF ASSEMBLY

CAPAGRIP™ K, L, M: Ease of Assembly with High Degree of Protection



terminal design	K	L	M
height above can (h)	26 mm	35 mm	45 mm
cable cross section	1 × 6 mm ² per contact ¹ 1 × 10 mm ² per contact ²	2 × 25 mm ² per contact ¹	2 × 35 mm ² per contact ¹ 2 × 50 mm ² per contact ²
max. current per phase	39A	56A	104A
fastening torque	1.2 ... 2.0 Nm	2.5 ... 3.0 Nm	3.2 ... 3.7 Nm
discharge resistors	included (< 50V within 60s)	separate module	separate module

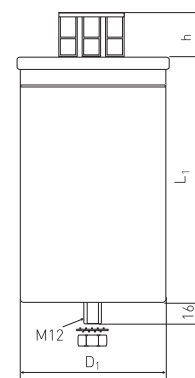
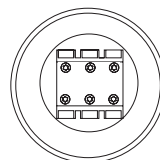
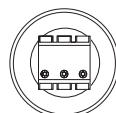

¹ (with ferrule - recommended)

² (without ferrule)

PROTECT YOUR FK-Dr™ THREE-PHASE DETUNING REACTORS – Protect your Capacitors from Resonances CAPACITORS

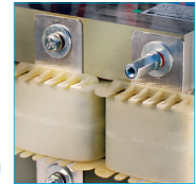

Contemporary practice of power factor correction has become unthinkable without the use of series reactors for blocking resonances with mains inductances and overloads. As a side effect, the overall level of harmonic distortion is also reduced to a considerable extent.

We manufacture our three phase filter reactors of specially selected transformer sheets and aluminium band. Alternatively, copper windings are available on request. Unlike many low-end products, our aluminium reactors are connected through copper terminals for long-term reliable connection.

The FK-Dr™ reactors are dried and impregnated in a vacuum with environmentally-friendly, low-styrole resin which ensures they can withstand high voltages, have low noise levels, and offer a long operating life. High-class iron cores with multiple air gaps as well as a staid designing approach

guarantee high current linearity and low heat dissipation losses, at the same time allowing for compact dimensions and competitive cost. The operating temperature of the reactor can be monitored externally by an integrated thermal switch (125°C).

Along with the common standard-rated reactors (for the usual range of capacitors) we offer a range of special reactors which, combined with properly-rated capacitors, produce exactly the required kvar output at mains voltage, allowing for reduced size and cost of your installation.

For more detailed information, please order our comprehensive catalogue „KEY COMPONENTS FOR POWER FACTOR CORRECTION“

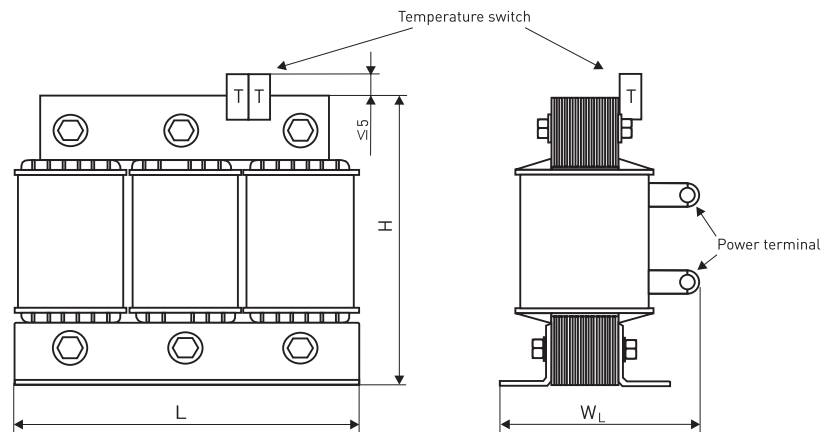

GENERAL TECHNICAL DATA

design	three phase, iron core with multiple air gaps, IP00
tolerance of inductance	- 3 ... + 3%
terminals	copper lugs; cables available on request
winding material	aluminium band; copper winding available on request
safety device	thermal switch (125°C ± 5K)
impregnant	polyester resin Class F
current linearity	1.8 × I _N , higher values on request
permitted harmonic load	U ₃ = 0.5% U _N U ₅ = 6% U _N U ₇ = 5% U _N U ₁₁ = 3.5% U _N U ₁₃ = 3% U _N
insulation voltage winding to core	3kV
max. relative humidity	95%
temperature class	T40
statistical life expectancy	> 200 000 h
standards	EN61558-2-20:2000, VDE 0570-2, IEC 60076-6:2007, UL508, CSA22.2/14
certificates	

BLOCKING MKPg™ + FK-Dr™: The Perfect Match for your PFC System RESONANCES

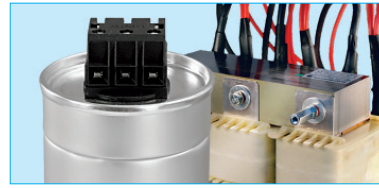

Reactors for standard capacitors (Non-adjusted rating):

A „non-adjusted reactor” is matched to a power capacitor with standard rating at system voltage. Mind that with the increased output of kvar due to voltage rise inside the resonance circuit, more power output is installed than actually required by the customer.

NET output at 400V (kvar)	Capacitor 440V 50Hz (480V available on request)				7% Reactor 440V 50Hz			
	Q _C (kvar)	C _N (μF)	D ₁ x L ₁ (mm)	order code	inductance (mH)	I _{rms} (A)	L x H x W _L (mm)	order no.
13.4	15	3 × 82	85 × 230	275.556-508200	3 × 2.88	22.5	240 × 215 × 160	428.124+40D3A
26.9	30	3 × 166	116 × 230	275.186-516600	3 × 1.42	46.6	240 × 215 × 185	444.326+40D3A
53.8	60	2 pcs × 3 × 166	116 × 230	275.186-516600	3 × 0.71	91.2	300 × 190 × 240	458.260+40D3A
80.6	90	3 pcs × 3 × 166	116 × 230	275.186-516600	3 × 0.48	138.6	300 × 265 × 240	468.160+40D3A0
107.6	120	4 pcs × 3 × 166	116 × 230	275.186-516600	3 × 0.36	182.4	420 × 188 × 370	4H0.218+40D3A0

Specially adapted capacitors and reactors (Adjusted rating):

The kvar output of a capacitor depends on the voltage it is charged with. At higher voltage, equal capacitance delivers more kvar.

A reactor with adjusted rating is allowing for the internal voltage rise inside the resonating circuit of capacitor/reactor, and matched to a specially dimensioned capacitor with reduced capacitance.

Advantage: The exact power is installed as required by the customer, and switching devices are stressed less. Both capacitor and reactor are smaller than the non-adjusted solution. Note that exact sizing of the capacitor is necessary.

NET output at 400V (kvar)	Capacitor 440V 50Hz (480V available on request)				7% Reactor 440V 50Hz			
	Q _C (kvar)	C _N (μF)	D ₁ x L ₁ (mm)	order code	inductance (mH)	I _{rms} (A)	L x H x W _L (mm)	order no.
12.5	14.1	3 × 77	85 × 230	275.556-507700	3 × 3.07	21.2	240 × 215 × 160	428.124+40D3A
25	28.2	3 × 154	116 × 230	275.186-515400	3 × 1.54	42.3	240 × 215 × 180	444.126+40D3A
50	56.4	2 pcs 3 × 154	116 × 230	275.186-515400	3 × 0.77	84.6	300 × 190 × 230	458.259+40D3A
75	84.6	3 pcs 3 × 154	116 × 230	275.186-515400	3 × 0.51	127	300 × 265 × 230	468.159+40D3A
100	112.8	4 pcs 3 × 154	116 × 230	275.186-515400	3 × 0.38	144.3	300 × 265 × 240	4H0.160+40D3A0

DISCHARGE DISCHARGE MODULES - The Convenient Match

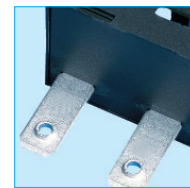

Capacitors of the CAPAGRIP™ K series are fitted with discharge resistors for a discharge < 50V within < 60 seconds. For CAPAGRIP™ L and M, we provide separate resistor modules in a finger-proof housing (IP20) for fast and convenient connection to the terminal.

resistance (kΩ)	U _{max} (V)	L (mm)	order no.
3 × 82	400 V	27	275.100-10082
3 × 100	530 V	48	275.105-10100
3 × 120	600 V	48	275.105-10120
3 × 120	480 V	27	275.100-10120
3 × 180	600 V	27	275.100-10180

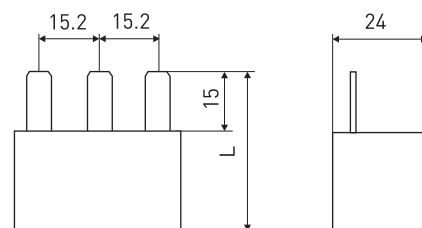

IMPORTANT REMARKS

Safety

ELECTRONICON will not indemnify or be responsible for any kind of damages to persons or property due to the improper application of any capacitors or reactors purchased from **ELECTRONICON** or its distributors. The capacitors and reactors should only be used for the application intended.

Mind that electrical or mechanical misapplication of capacitors and reactors can become hazardous. Misapplied capacitors can explode or catch fire and cause bodily injury or property damage due to the expulsion of material or metal fragments.

Please consult the detailed instructions for mounting and application stated in our long-version Catalogue brochure „Capacitors and Reactors For Power Factor Correction“, and on the **ELECTRONICON** website. If in doubt about how to connect, operate, or discharge a capacitor, consult **ELECTRONICON** engineering.

Mounting And Cooling

The useful life of a capacitor may be reduced dramatically if exposed to excessive heat. Typically an increase in the ambient temperature of 7°C will halve the expected life of the capacitor. Make sure to obey the permitted operating temperatures of ambient temperature class D (max. temperature 55°C, max. average over 24hrs. 45°C, max. average over 365 days 35°C). To avoid overheating the capacitors must be allowed to cool unhindered and should be shielded from external heat sources. We recommend forced ventilation for all applications with detuning reactors. Give at least 20mm clearance between the capacitors for natural or forced ventilation, and do not place them directly above or next to heat sources such as detuning or tuning reactors, bus bars, etc.

Protection against Overvoltages And Short Circuits: Self-Healing Dielectric

All dielectric structures used in our power capacitors are „self-healing“: In the event of a voltage breakdown the metal layers around the breakdown channel are evaporated by the temperature of the electric arc that forms between the electrodes. They are removed within a few microseconds and pushed apart by the pressure generated in the centre of the breakdown spot. An insulation area is formed which is reliably resistive and voltage proof for all operating requirements of the capacitor. The capacitor remains fully functional during and after the breakdown. For voltages within the permitted testing and operating limits the capacitors are short-circuit- and overvoltage-proof.

They are also proof against external short circuits as far as the resulting surge discharges do not exceed the specified surge current limits.

Functioning of the BAM™ (Break Action Mechanism)

In the event of overvoltage or thermal overload or ageing at the end of the capacitor's useful service life, an increasing number of self-healing breakdowns may cause rising pressure inside the capacitor.

To prevent it from bursting, the capacitor is fitted with an obligatory „break action mechanism“ (BAM).

The BAM™ is based on an attenuated spot at one of the connecting wires inside the capacitor. With rising pressure the case begins to expand, mainly by opening the folded crimp and pushing the lid upwards. As a result, the prepared connecting wire is separated at the attenuated spot, and the current path is interrupted irreversibly.

Warning:

It has to be noted that this safety system can act properly only within the permitted limits of loads and overloads. The simple presence of a safety mechanism does not mean that catastrophic failures are completely impossible. Strong overvoltages, permanent external heat, and heavy current overload, e.g. during harmonic resonances may cause sudden, uncontrollable rise of temperature and pressure inside the can which may not leave sufficient time for the BAM™ to act properly, and result in explosion and fire.

For more detailed information, please order our long-version catalogue „Capacitors and Reactors for Power Factor Correction“, and the „General Safety Advice for Power Capacitors“ issued by the German Electrical and Electronic Manufacturer's Association (ZVEI).

3 Year Limited Warranty

All our products are designed, manufactured, and tested with the highest care and workmanship. The satisfaction of our customers is our highest goal. We therefore warrant remedying any defect in the goods resulting from faulty design, materials or workmanship, which appears within 3 years from the date of sale.

This warranty does not cover defects due to improper use of the goods or operation at conditions exceeding the rated values stated in the catalogue or special data sheet. Nor does it cover defects due to faulty maintenance or incorrect installation, alterations or faulty repairs undertaken by the Buyer. Finally the warranty does not cover normal wear and tear or deterioration. See our „General Conditions“ for details on Warranty and Product liability.



Find more information, detailed instructions and other important components (PF controllers, thyristor switches, a.m.) in our long version catalogue „KEY COMPONENTS FOR POWER FACTOR CORRECTION“ and on www.electronicon.com